

Turntable System

Operating Instructions

Model No. **SL-1210M3D**

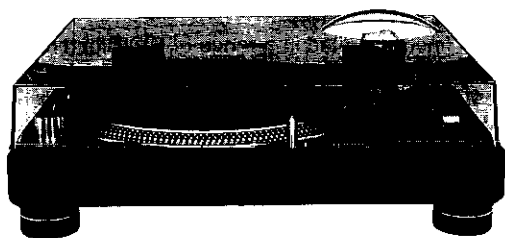

Technics®



EB E GN

Note:

"EB" on the packaging indicates the United Kingdom.

Before connecting, operating or adjusting this product, please read these instructions completely. Please keep this manual for future reference.

RQT5839-1B









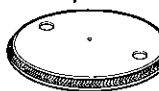

Thank you for purchasing this product.
For optimum performance and safety, please read these instructions carefully.

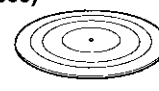
Table of contents

Supplied accessories	2
Features	2
Caution for AC mains lead	3
Safety precautions	3
Controls	4
Preparation of the cartridge	4
Putting the player together	5
Connections and installation	6
Connecting the stereo phono cable and AC mains lead	6
Connection to the Audio Mixer	6
Installation	6
Preparatory adjustments	7
Horizontal balance and stylus pressure	7
Anti-skating	8
Tone arm height	8
Fit the dust cover	8
Playing records	9
Adjustments while using the unit	10
Pitch control	10
Armlift height	10
Maintenance	11
Troubleshooting guide	Back cover
Specifications	Back cover

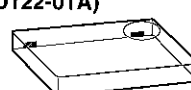
Supplied accessories

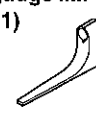
Please check and identify the supplied accessories.
(For the United Kingdom only)
Use numbers indicated in parentheses when asking for replacements parts.

<input checked="" type="checkbox"/> 	
<input type="checkbox"/> Turntable 1pc. (SFTE172-01Z)	<input type="checkbox"/> Balance weight 1pc. (SFPWG17201K)
	
<input type="checkbox"/> Turntable mat 1pc. (RGS0008)	<input type="checkbox"/> Auxiliary weight 1pc. (SFPWG17202)
	
<input type="checkbox"/> Disc slip sheet set (RGS0005Z) 1 • Disc slip sheet • Transparent sheet	<input type="checkbox"/> EP record adaptor (SFWE010) 1pc.
	
<input type="checkbox"/> Dust cover 1pc. (SFAD122-01A)	<input type="checkbox"/> Shell weight 1pc. (SFPZB3501)
	
<input type="checkbox"/> Head shell (with stylus weight) (SFPCC31005K) 1pc.	<input type="checkbox"/> Overhang gauge 1pc. (SFK0135-01)
	
<input type="checkbox"/> Screw set for cartridge 1 • Nuts(RHN26003) • Screws-short(SFCZV8801-1) • Screws-long(SFPEV9801-1) • Washers(SFPEW9601)	<input type="checkbox"/> Screw set for cartridge 1
	

A cartridge is not included.

Features

A masterpiece amongst turntables with a worldwide reputation.

Pitch control reset button

- Pitch can be instantly reset to the rated speed (33 1/3 or 45 r/min).

Highly accurate turntable speed maintained continuously with a quartz pitch control

- The pitch can be varied between -8 and +8%, with accuracy maintained throughout the range.

The direct drive produces high torque

- Wow and flutter below 0.01%. Starting torque of 1.5 kg-cm enabling the turntable to reach 33 1/3 r/min in 0.7 seconds.

- Fully electric braking system.

Tone arm with gimbal suspension

- The tone arm can be finely adjusted in a range of 6 millimeters with the lockable height control.

Anti-vibration design with 3 layer cabinet construction and large insulating legs.

Pop-up stylus light.

WARNING:

TO REDUCE THE RISK OF FIRE, ELECTRIC SHOCK OR PRODUCT DAMAGE, DO NOT EXPOSE THIS APPARATUS TO RAIN, MOISTURE, DRIPPING OR SPLASHING AND THAT NO OBJECTS FILLED WITH LIQUIDS, SUCH AS VASES, SHALL BE PLACED ON THE APPARATUS.

CAUTION!

- DO NOT INSTALL, OR PLACE THIS UNIT, IN A BOOKCASE, BUILT-IN CABINET OR IN ANOTHER CONFINED SPACE. ENSURE THE UNIT IS WELL VENTILATED. TO PREVENT RISK OF ELECTRIC SHOCK OR FIRE HAZARD DUE TO OVERHEATING, ENSURE THAT CURTAINS AND ANY OTHER MATERIALS DO NOT OBSTRUCT THE VENTILATION VENTS.
- DO NOT OBSTRUCT THE UNIT'S VENTILATION OPENINGS WITH NEWSPAPERS, TABLECLOTHS, CURTAINS, AND SIMILAR ITEMS.
- DO NOT PLACE SOURCES OF NAKED FLAMES, SUCH AS LIGHTED CANDLES, ON THE UNIT.
- DISPOSE OF BATTERIES IN AN ENVIRONMENTALLY FRIENDLY MANNER.
- THIS UNIT IS INTENDED FOR USE IN MODERATE CLIMATES.

SUOMI

VAROITUS:

TULIPALLO-, SÄHKÖISKUVAARAN TAI TUOTETTA KOHTAAVAN MUUN VAHINGON VÄHENTÄMISEKSI EI LAITETTA SAA ALTISTAA SATEELLE, KOSTEUDELLE, VESIPISAROILLE TAI ROISKEELLE, EIKÄ NESTETTÄ SISÄLTÄVIÄ ESINEITÄ, KUTEN ESIMERKIKSI MALJAKOITA, SAA ASETTAA LAITTEEN PÄÄLLE.

VAROITUS!

- ÄLÄ ASENNATA TAI LAITA TÄTÄ LAITETTA KABINETTITYYPPISEEN KIRJAKAAPPIN TAI MUUHUN SULJETTUUN TILAAN, JOTTA TUULETUS ONNISTUISI. VARMISTA, ETTÄ VERHO TAI MIKÄÄN MUU MATERIAALI EI HUONONNA TUULETUSTA, JOTTA VÄLTETTÄISIIN YLIKUUMENEMISESTÄ JOHTUVA SÄHKÖISKU- TAI TULIPALOVAARA.
- ÄLÄ PEITÄ LAITTEEN TUULETUSAUKKOJA SANOMALEHDellä, PÖYTÄLIINALLA, VERHOLLA TAI MUULLA VASTAAVALLA ESINEELLÄ.
- ÄLÄ ASETA PALAVAA KYNTTILÄÄ TAI MUUTA AVOTULEN LÄHDETTÄ LAITTEEN PÄÄLLE.
- HÄVITÄ PARISTOT LUONTOA VAHINGOITAMATTOMALLA TAVALLA.
- TÄMÄ LAITE ON TARKOITETTU KÄYTETTÄVÄKSI LEUDOSSA ILMASTOSSA.

NORSK

ADVARSEL:

FOR Å REDUSERE FAREN FOR BRANN, ELEKTRISK STØT ELLER SKADER PÅ PRODUKTET, MÅ DETTE APPARATET IKKE UTSETTES FOR REGN, FUKTIGHET, VANNDRÅPER ELLER VANNSPRUT. DET MÅ HELLER IKKE Plasseres GJENSTANDER Fylt MED VANN, SLIK SOM BLOMSTERVASER, OPPÅ APPARATET.

ADVARSEL!

- APPARATET MÅ IKKE Plasseres I EN BOKHYLLE, ET INNEBYGGET KABINETT ELLER ET ANNET LUKKET STED HVOR VENTILASJONSFORHOLDENE ER UTILSTREKKELIGE. SØRG FOR AT GARDINER ELLER LIGNENDE IKKE FORVERRRER VENTILASJONSFORHOLDENE, SÅ RISIKO FOR ELEKTRISK SHOKK ELLER BRANN FORÅRSAKET AV OVERHETING UNNGÅS.
- APPARATETS VENTILASJONSÅPNINGER MÅ IKKE DEKKES TIL MED AVISER, BORDDUKER, GARDINER OG LIGNENDE.
- Plasser IKKE ÅPEN ILD, SLIK SOM LEVENDE LYS, OPPÅ APPARATET.
- BRUKTE BATTERIER MÅ KASSERES UTEN FARE FOR MILJØET.
- DETTE APPARATET ER BEREGNET TIL BRUK UNDER MODERATE KLIMAFORHOLD.

Caution for AC mains lead



(For United Kingdom) ("EB" area code model only)

For your safety, please read the following text carefully.

This appliance is supplied with a moulded three pin mains plug for your safety and convenience.

A 5-ampere fuse is fitted in this plug.

Should the fuse need to be replaced please ensure that the replacement fuse has a rating of 5-ampere and that it is approved by ASTA or BSI to BS1362.

Check for the ASTA mark  or the BSI mark  on the body of the fuse.

If the plug contains a removable fuse cover you must ensure that it is refitted when the fuse is replaced.

If you lose the fuse cover the plug must not be used until a replacement cover is obtained.

A replacement fuse cover can be purchased from your local dealer.

CAUTION!

IF THE FITTED MOULDED PLUG IS UNSUITABLE FOR THE SOCKET OUTLET IN YOUR HOME THEN THE FUSE SHOULD BE REMOVED AND THE PLUG CUT OFF AND DISPOSED OF SAFELY.

THERE IS A DANGER OF SEVERE ELECTRICAL SHOCK IF THE CUT OFF PLUG IS INSERTED INTO ANY 13-AMPERE SOCKET.

If a new plug is to be fitted please observe the wiring code as stated below.

If in any doubt please consult a qualified electrician.

IMPORTANT

The wires in this mains lead are coloured in accordance with the following code:

Blue: Neutral, Brown: Live.

As these colours may not correspond with the coloured markings identifying the terminals in your plug, proceed as follows:

The wire which is coloured Blue must be connected to the terminal which is marked with the letter N or coloured Black or Blue.

The wire which is coloured Brown must be connected to the terminal which is marked with the letter L or coloured Brown or Red.

WARNING: DO NOT CONNECT EITHER WIRE TO THE EARTH TERMINAL WHICH IS MARKED WITH THE LETTER E, BY THE EARTH SYMBOL  OR COLOURED GREEN OR GREEN/YELLOW.

THIS PLUG IS NOT WATERPROOF—KEEP DRY.

Before use

Remove the connector cover.

How to replace the fuse

The location of the fuse differ according to the type of AC mains plug (figures A and B). Confirm the AC mains plug fitted and follow the instructions below.

Illustrations may differ from actual AC mains plug.

1. Open the fuse cover with a screwdriver.

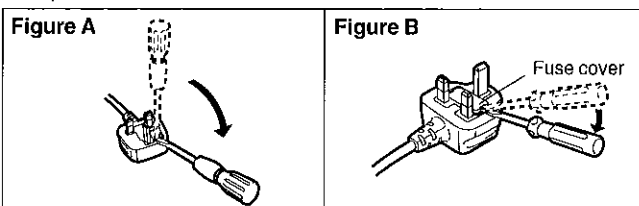

2. Replace the fuse and close or attach the fuse cover.

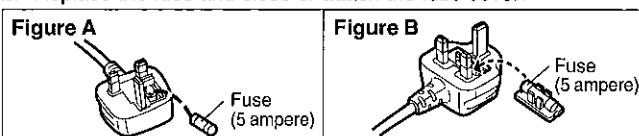

Safety precautions

Placement

Set the unit up on an even surface away from direct sunlight, high temperatures, high humidity, and excessive vibration. These conditions can damage the cabinet and other components, thereby shortening the unit's service life.

Do not place heavy items on the unit.

Voltage

Do not use high voltage power sources. This can overload the unit and cause a fire.

Do not use a DC power source. Check the source carefully when setting the unit up on a ship or other place where DC is used.

AC mains lead protection

Ensure the AC mains lead is connected correctly and not damaged. Poor connection and lead damage can cause fire or electric shock. Do not pull, bend, or place heavy items on the lead.

Grasp the plug firmly when unplugging the lead. Pulling the AC mains lead can cause electric shock.

Do not handle the plug with wet hands. This can cause electric shock.

Foreign matter

Do not let metal objects fall inside the unit. This can cause electric shock or malfunction.

Do not let liquids get into the unit. This can cause electric shock or malfunction. If this occurs, immediately disconnect the unit from the power supply and contact your dealer.

Do not spray insecticides onto or into the unit. They contain flammable gases which can ignite if sprayed into the unit.

Service

Do not attempt to repair this unit by yourself. If sound is interrupted, indicators fail to light, smoke appears, or any other problem that is not covered in these operating instructions occurs, disconnect the AC mains lead and contact your dealer or an authorized service center. Electric shock or damage to the unit can occur if the unit is repaired, disassembled or reconstructed by unqualified persons.

Extend operating life by disconnecting the unit from the power source if it is not to be used for a long time.

A Controls

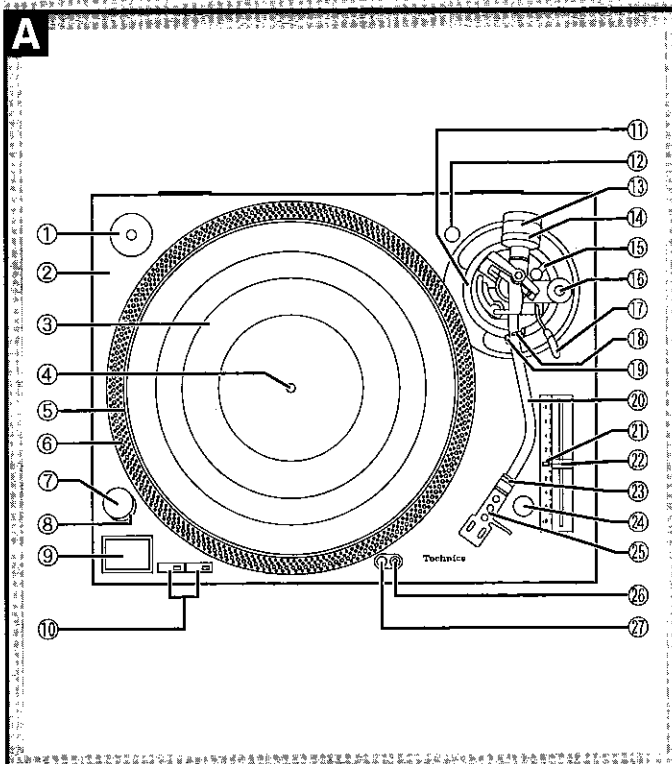

No.	Name	Reference page(s)
1	EP record adaptor	9
2	Turntable base	4
3	Turntable mat (Or disc slip sheet)	5
4	Center spindle	5
5	Turntable	5
6	Strobe mirrors	10
7	Power switch (power)	9
8	Strobe light, pilot lamp	10
9	Start-stop button (start - stop)	9
10	Speed select buttons (33, 45)	9
11	Arm-height control	8
12	Shell stand	4
13	Balance weight	5
14	Stylus pressure control	7
15	Arm lock	8
16	Anti-skating control	8
17	Cue lever	7
18	Arm clamp	7
19	Arm rest	7
20	Tone arm	5
21	LED indicator	10
22	Pitch control (Pitch adj.)	10
23	Locking nut	5
24	Reset button (reset)	10
25	Head shell	4
26	Stylus light switch	9
27	Stylus light	9

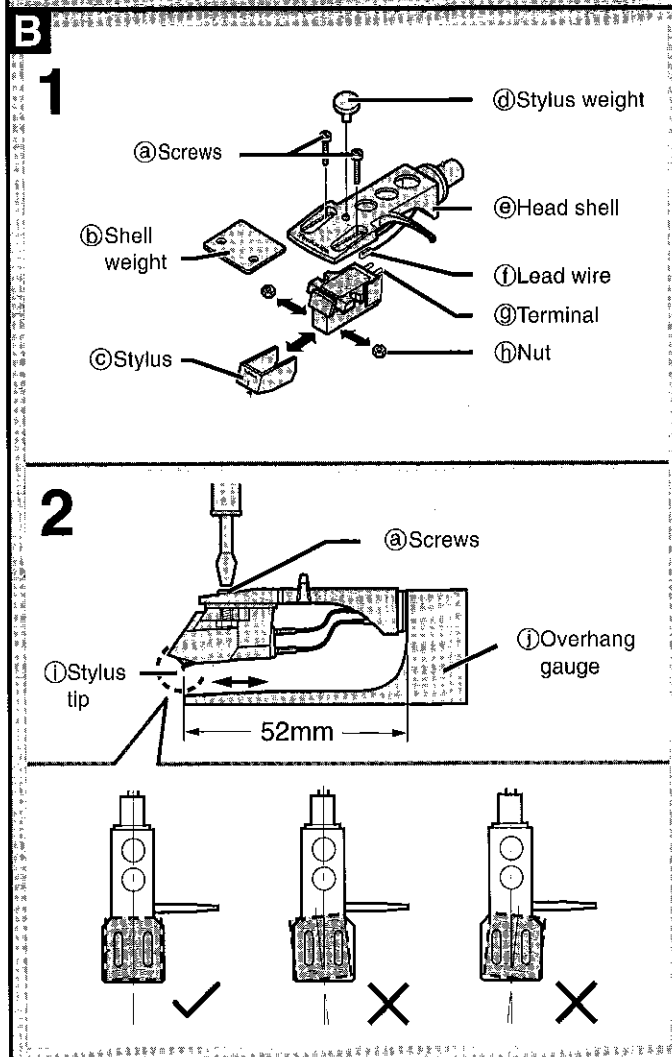

B Preparation of the cartridge

- ### 1 Attach a cartridge (not included).

Follow the cartridge's instructions to correctly attach it to the head shell (e).

 - Use the included shell weight (b) when using a light cartridge (3.5 to 6.5 grams).
 - Use the stylus weight (d) to increase stylus pressure (→ page 7). Leave it off until stylus pressure has been adjusted.

c) Stylus
 f) Lead wire
 g) Terminal
 h) Nut
- ### 2 Adjust the overhang.

Fit the included overhang gauge (i) to the head shell. Adjust the overhang and facing of the cartridge and tighten the screws (a).

 - Line the stylus tip (j) up with the end of the gauge.
 - The cartridge should be parallel on the shell head.

Putting the player together

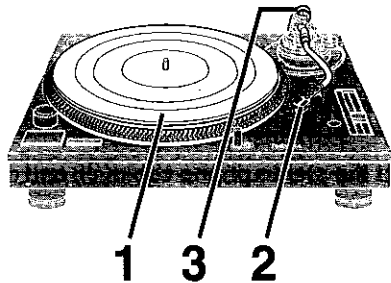

Put the player together in the following order.

- Do not connect the AC mains lead until set up is complete.
- Leave the dust cover off until set up and adjustments are complete.

1 Fit the turntable(②) and turntable mat(①).

Put the turntable on the center spindle and then lay the mat on top.

• Be very careful when putting the turntable on the main unit. The magnet(③) on the bottom of the turntable is finely adjusted and sharp contact can cause it to move and lead to poor operation. Ensure the magnet remains free from dust and iron particles.

• Do not adjust the screws attaching the magnet to the turntable(④). The rated performance of the unit cannot be guaranteed if the magnet is moved.

2 Attach the head shell(⑤).

Fit the head shell into the tone arm, keep it horizontal and tighten the locking nut(⑥).

3 Attach the balance weight(⑧) to the rear of the tone arm.

If the cartridge weighs between 10 and 13 grams, attach the included auxiliary weight(⑨) to the main balance weight.

A When the player is to be used for scratch play.

Use the disc slip sheet(⑩) instead of the turntable mat. This enables the record to be easily moved during play.

- Top (printed side): Lay the record on this side.
- Bottom: Slippery side.

For a different kind of slip

Put the transparent sheet(⑪) under the disc slip sheet.

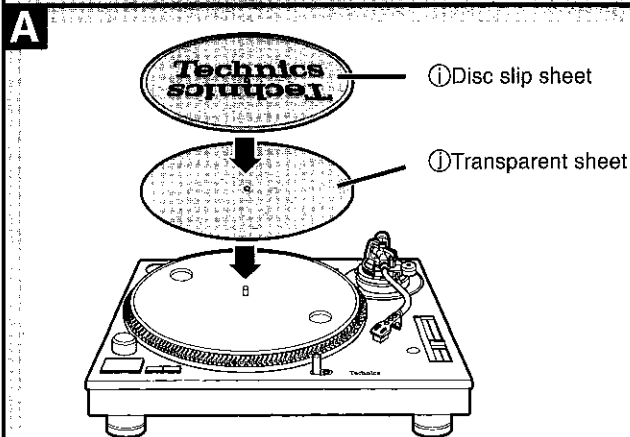
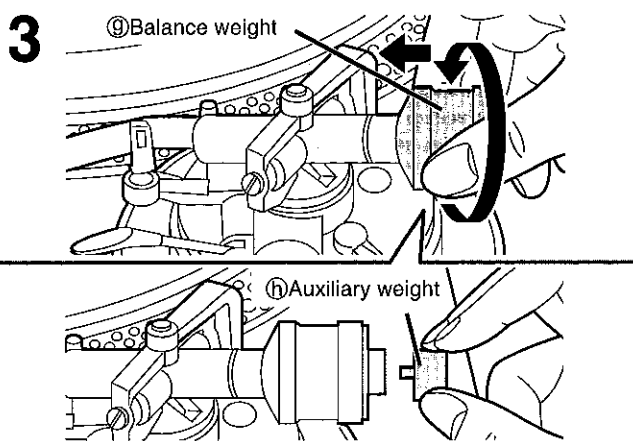
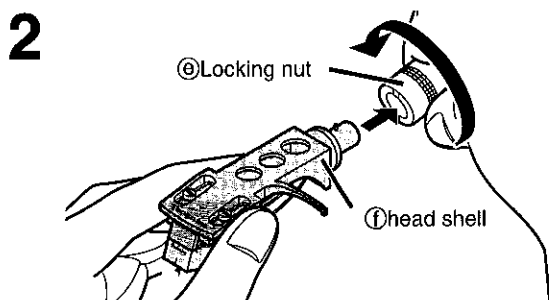
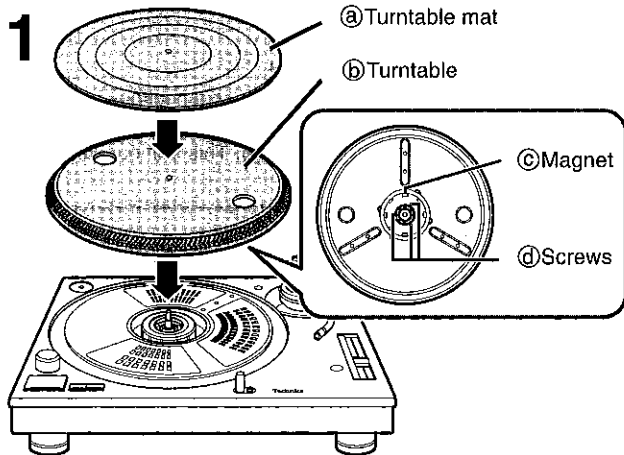

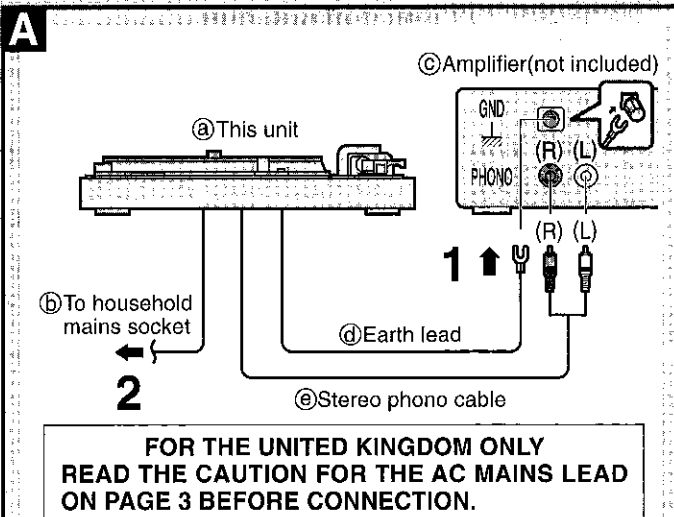

A Connecting the stereo phono cable and AC mains lead

1. Connect the stereo phono cable (Ⓓ) and earth lead (Ⓒ).

stereo phono cable White (L)

 Red (R)

© Amplifier

If the earth lead isn't connected, a hum will be heard from the AC power source.

2. Connect the AC mains lead.

- Connect this cord only after all other connections are complete.
 - Confirm the wattage of AC outlets on amplifiers and receivers before using them for this unit (Ⓐ). This unit consumes 16 W.
- ⓑ To household mains socket

B For your reference

There is an AC line-voltage selector under the turntable. This allows you to change the voltage if you move to an area with a lower voltage. Check the voltage of your area before using the unit. If the selector needs to be changed, turn it with a screwdriver.

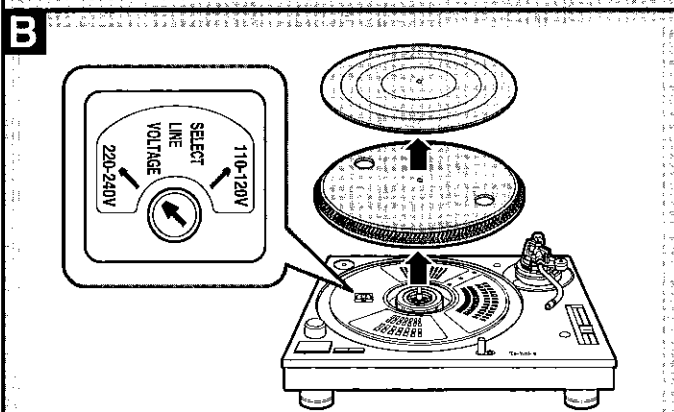

C Connection to the Audio Mixer (Ⓕ) (not included)

- Disconnect all units from the power source before making any connections.
- Reconnect the AC mains leads after all other connections are complete.

Ⓐ This unit

Ⓒ Earth lead

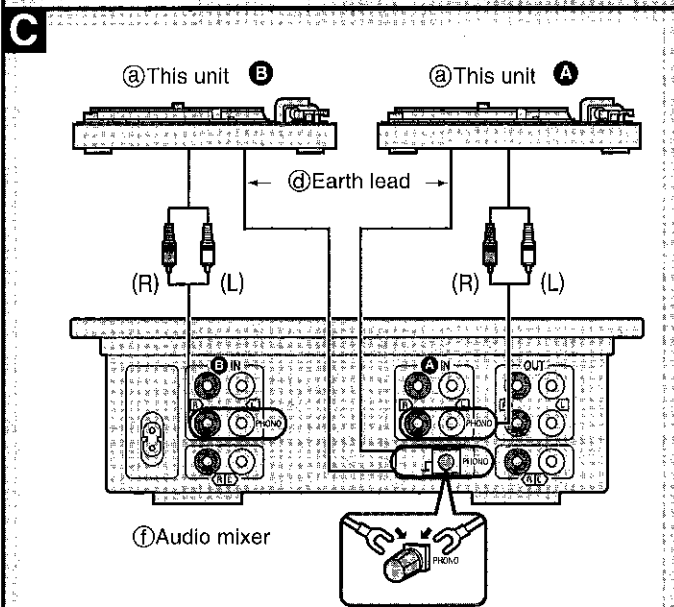

Installation

- Install the unit on a horizontal surface protected from vibrations.
- Keep this unit as far as possible from speakers.

Note

- Ensure the unit is not exposed to direct sunlight, dust, humidity, and heat from a heating appliance.
- This unit may pick up interference from a radio if there is one nearby. Keep radios as far as possible from this unit.

D Adjusting the height of the insulators

Place the unit where it is to be used and adjust the height of the legs to make the unit horizontal.

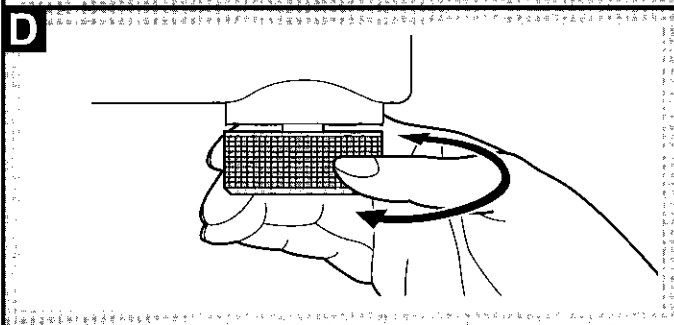

Preparatory adjustments

Horizontal balance and stylus pressure

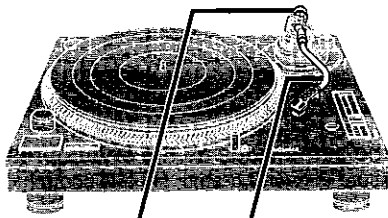

2,3,4 1

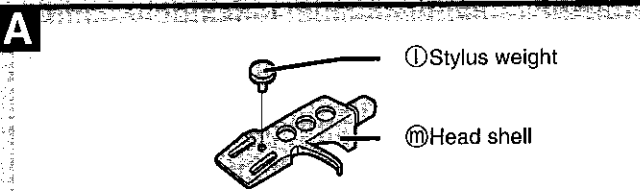
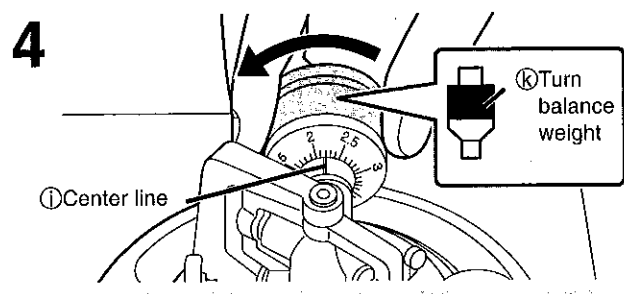
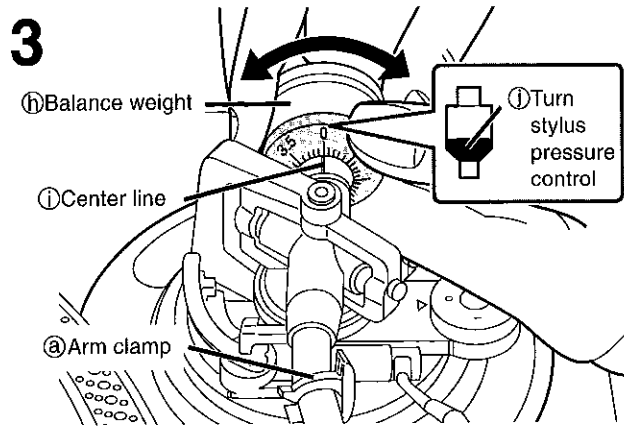
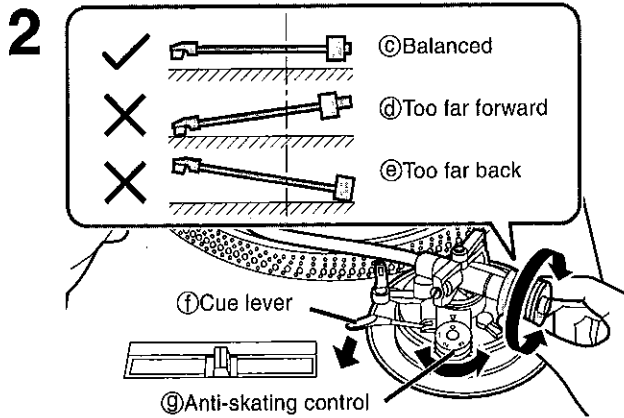
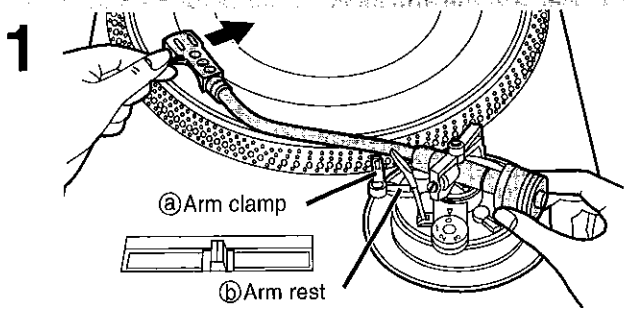

- 1 Release the tone arm.**
 1. Remove the stylus cover, taking care not to damage the stylus, then release the arm clamp(2).
 2. Free the tone arm from the arm rest(3).

- 2 Adjust horizontal balance**
 1. Push the cue lever(1) down.
 2. Turn the anti-skating control(2) to "0".
 3. Turn the balance weight until the arm is approximately horizontal.
 - 3 Balanced
 - 4 Too far forward
 - 5 Too far back

Take care at this time not to allow the stylus to touch the unit.

- 3 Turn the stylus pressure control to "0"**
 1. Return the tone arm to the arm rest and fix it with the arm clamp.
 2. Turn the stylus pressure control(1) to "0". Hold the balance weight(2) still while doing this.

- 4 Adjust stylus pressure**

Turn the balance weight(2) to adjust to the appropriate pressure for the cartridge you are using. See the cartridge's instructions for recommended stylus pressure.

The stylus pressure control will turn at the same time. Stop when the center line(1) points to the required pressure.

For your reference
Use the stylus weight(1) (included) to increase stylus pressure by 4 grams. **A**
① Head shell

Adjustments while using the unit

A Pitch control

Fine adjustment to the number of revolutions per minute.

Slide [pitch adj.] while the turntable is revolving.

Move the indicator to the required position.

- The numbers represent approximate percentages.
- Pitch can be adjusted between -8% to +8%.

To reset pitch to the preset value

Press [reset] (ⓑ).

The LED indicator (ⓐ) lights and the pitch immediately returns to the set value (33 1/3 or 45 r/min), regardless of any adjustments made with [pitch adj.].

Press [reset] again and pitch returns to the adjusted value.

ⓑ To measure pitch

The four rows of strobe mirrors around the edge of the turntable can assist you in measuring pitch.

They are lit by the strobo light (ⓐ) as they pass and each row appears to stand still at a different pitch.

Avoid using fluorescent light while measuring pitch. The timing will be put out and accuracy will be affected.

- ⓐ +6 % variation
- ⓑ +3.3 % variation
- ⓒ Normal turntable speed
- ⓓ -3.3 % variation

C Armlift height

Preparation

1. Put a record on the turntable.
2. Take off the stylus cover and release the arm clamp.

Use a screwdriver to turn the armlift screw (ⓐ).

Make this adjustment only if the cartridge you are using makes it necessary.

- Turning the screw clockwise lowers the armlift (ⓐ).
- Turning the screw anti-clockwise raises the armlift.

Note

Armlift height (the distance between the record and stylus when the cue lever is raised) is set to between 8 and 13 millimeters at time of shipment.

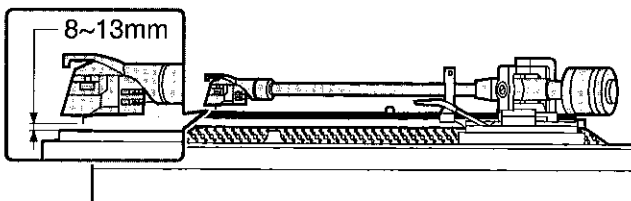
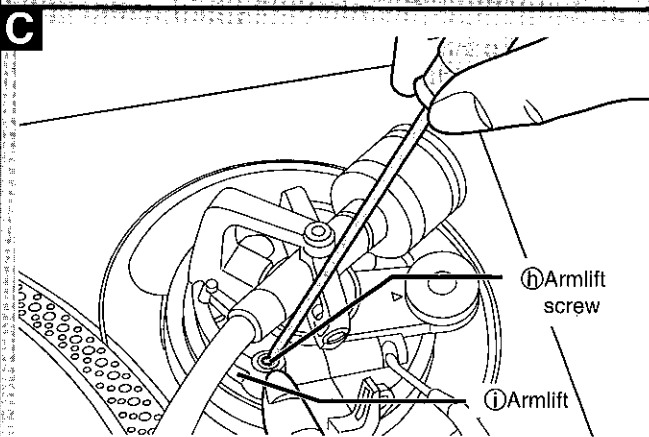
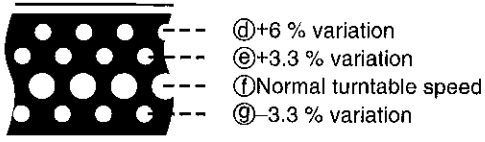
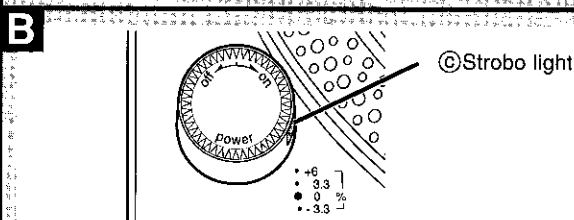
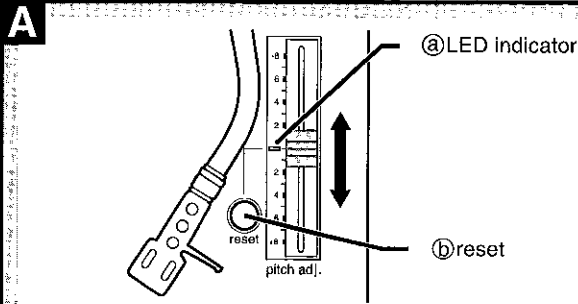
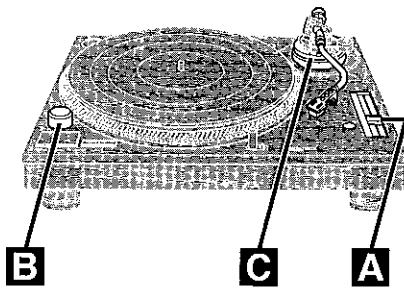

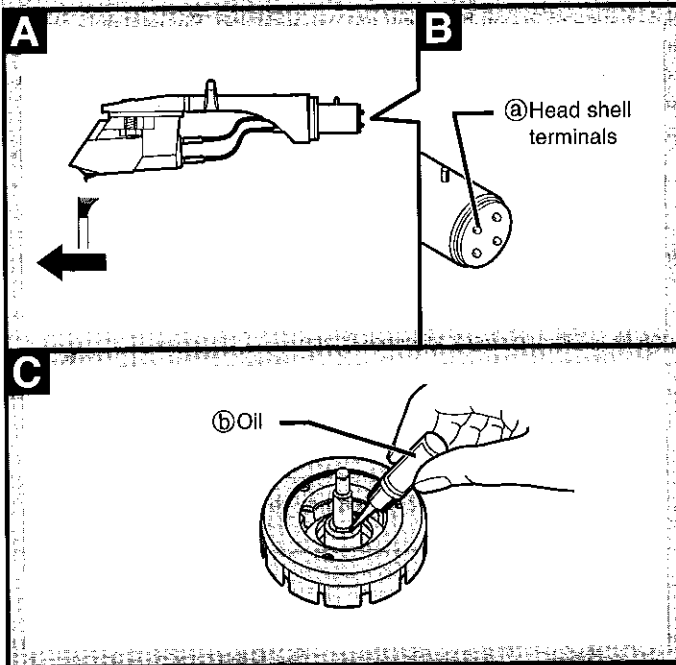

Care of the parts

To clean this unit, wipe with a soft, dry cloth.

If the surfaces are extremely dirty, use a soft cloth dipped in a soap-and-water solution or a weak detergent solution.

- Never use alcohol, paint thinner, or benzine to clean this unit.
- Before using chemically treated cloth, read the instructions that came with the cloth carefully.

Note

Do not wipe the dust cover while playing a record.

This can cause static electricity. This static can cause the tone arm to be attracted towards the cover.

A Thoroughly clean dust off the stylus and record.

- Use a soft brush to clean the stylus. Brush from the base to the tip.
- Use a good quality record cleaner to keep your records clean.

B Wipe the head shell terminals(a) occasionally.

Use a soft cloth. Turn the amplifier off before fitting or removing the head shell.

- Damage to your speakers can occur if the head shell is moved while the volume is turned up.
- Leave the stylus cover on while handling the head shell to prevent damaging the stylus.

C Oiling the center spindle.

Apply 2 or 3 drops every 2000 hours of operation. Use SFW0010 oil(o) (not included).

Moving the unit

Repackage the unit in the packaging it came in.

If you no longer have the packaging, do the following:

- Return the tone arm to the arm rest and tape it in place.
- Remove the balance weight and head shell from the tone arm and carefully wrap them.
- Take off the turntable and turntable mat and carefully wrap them.
- Carefully wrap the main unit in a blanket or paper.

Troubleshooting guide

Before requesting service for this unit, check the chart below for a possible cause of the problem you are experiencing. Some simple checks or a minor adjustment on your part may eliminate the problem and restore proper operation.

If you are in doubt about some of the check points, or if the remedies indicated in the chart do not solve the problem, refer to the directory of Authorized Service Centers (enclosed with this unit) to locate a convenient service center, or consult your dealer for instructions.

Problem	Probable cause(s)	Suggested remedy	Reference page(s)
No power.	Is the AC mains lead plugged in?	Plug the cord in firmly.	6
There is power but no sound.	Are connections to the amplifier or receiver correct?	Double check all connections.	6
Left and right sounds are reversed.	Are the stereo phono cable connections to the amplifier or receiver reversed?	Double check all connections.	6
Humming heard during play.	Are there other appliances or their AC mains leads near the stereo phono cable?	Separate the appliances and their AC mains leads from this unit.	—
	Is the earth lead connected?	Make sure the earth lead is correctly connected.	6

Specifications

Turntable section

Type	Quartz direct drive Manual turntable
Drive method	Direct drive
Motor	Brushless DC motor
Turntable platter	Aluminum diecast Diameter 33.2 cm Mass 1.7 kg
Turntable speeds	33 1/3 r/min, 45 r/min
Starting torque	1.5 kg·cm
Build-up characteristics	0.7 s. from standstill to 33 1/3 r/min
Braking system	Electronic brake
Wow and flutter	0.01 % WRMS* 0.025 % WRMS (JIS C5521) ±0.035 % peak (IEC 98A Weighted)
Rumble	-56 dB (IEC 98A Unweighted) -78 dB (IEC 98A Weighted)

※This rating refers to turntable assembly alone, excluding effects of record, cartridge or tonearm, but including platter. Measured by obtaining signal from built-in frequency generator of motor assembly.

General

Power supply	AC 110-120/220-240 V, 50 Hz
Power consumption	16 W
Dimensions (W×H×D)	45.3 × 16.2 × 35.3 cm
Mass	12 kg

Tonearm section

Type	Universal
Effective length	230 mm
Arm height adjustment range	0 - 6 mm
Overhang	15 mm
Effective mass	12 g (without cartridge)
Offset angle	22°
Friction	Less than 7 mg (lateral, vertical)
Tracking error angle	Within 2° 32' (at the outer groove of 30 cm record) Within 0° 32' (at the inner groove of 30 cm record)
Stylus pressure adjustment range	0 - 4 g
Applicable cartridge weight range	3.5 - 13 g
(with auxiliary weight)	11 - 20.5 g (including headshell) 9.5 - 13 g
(with shell weight)	17 - 20.5 g (including headshell) 3.5 - 6.5 g
Headshell weight	11 - 14 g (including headshell) 7.5 g

Note

Specifications are subject to change without notice.
Mass and dimensions are approximate.